



**jaga**



*Energy*  
**SAVERS**  
LOW-H<sub>2</sub>O

**STRADA**

€ 2018.ES



Energy  
**SAVERS**  
LOW-H<sub>2</sub>O



# STRADA

Fuerza cálida, regio diseño

- Robusta carcasa con panel frontal liso y estilizada rejilla de aluminio.
- Parcialmente premontado para una rápida instalación.
- Tecnología Low-H<sub>2</sub>O con intercambiador de calor superconductor y ultrarápido para mínimo consumo de energía y máxima emisión de calor.
- Twin Power para una compensación más rápida del aire frío proveniente de las fachadas acristaladas o de las rejillas de ventilación en la ventana.
- Modelo DBE para superbajas temperaturas de agua desde 28°C.
- Opcional: unidad de ventilación Oxygen Home integrado para renovación de aire.
- Valvulería integrada y conexión oculta.
- Temperatura de contacto segura.
- **30 años de garantía** en el intercambiador de calor.



design award  
winner

**OPCIÓN DBE** para altas emisiones con tamaños muy reducidos a superbajas temperaturas de agua desde 28°C.



LOW-H<sub>2</sub>O  
ELEGIDO EL  
RADIADOR  
MÁS ECONÓMICO

STRADA

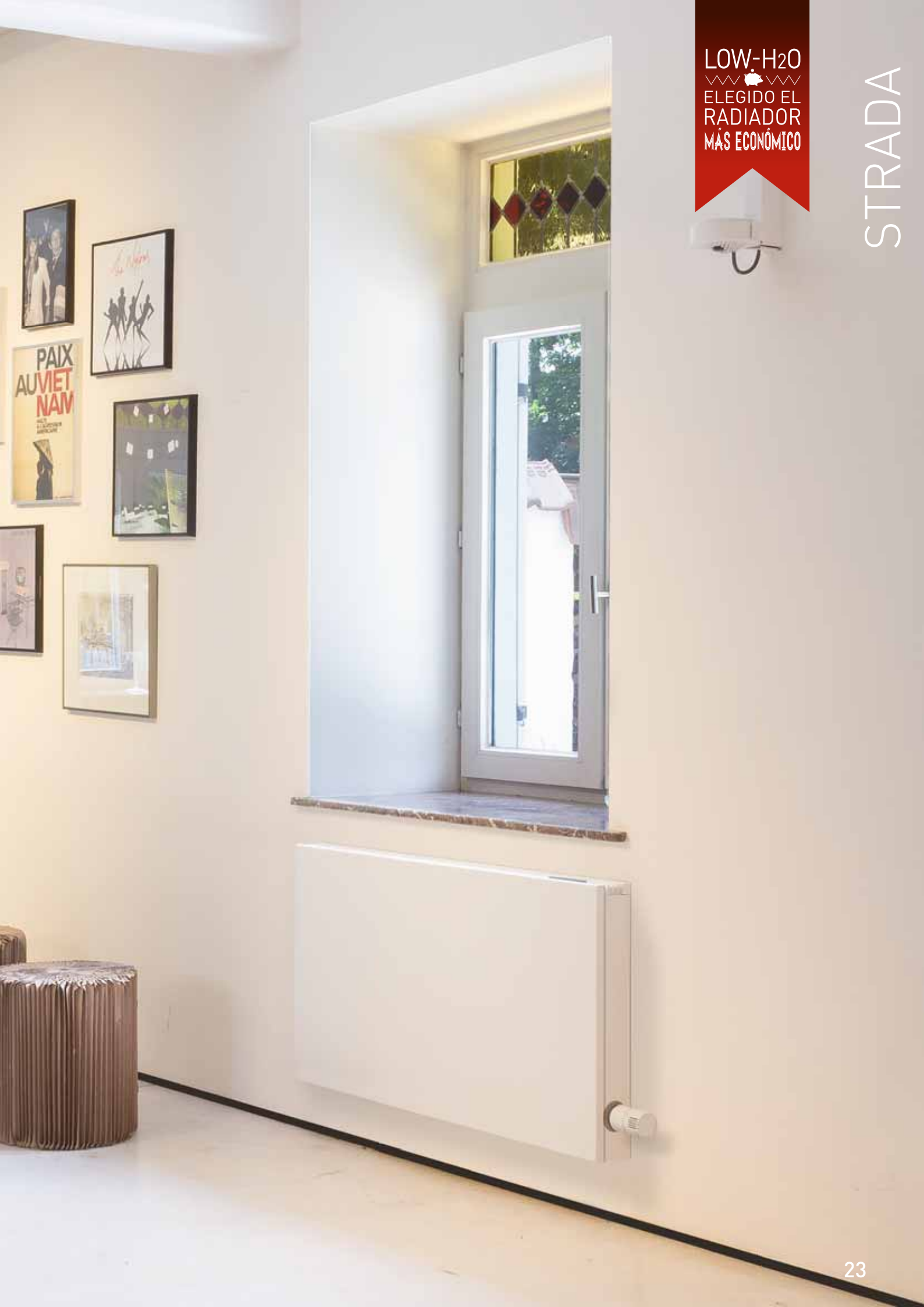

## DIMENSIONES (en cm)

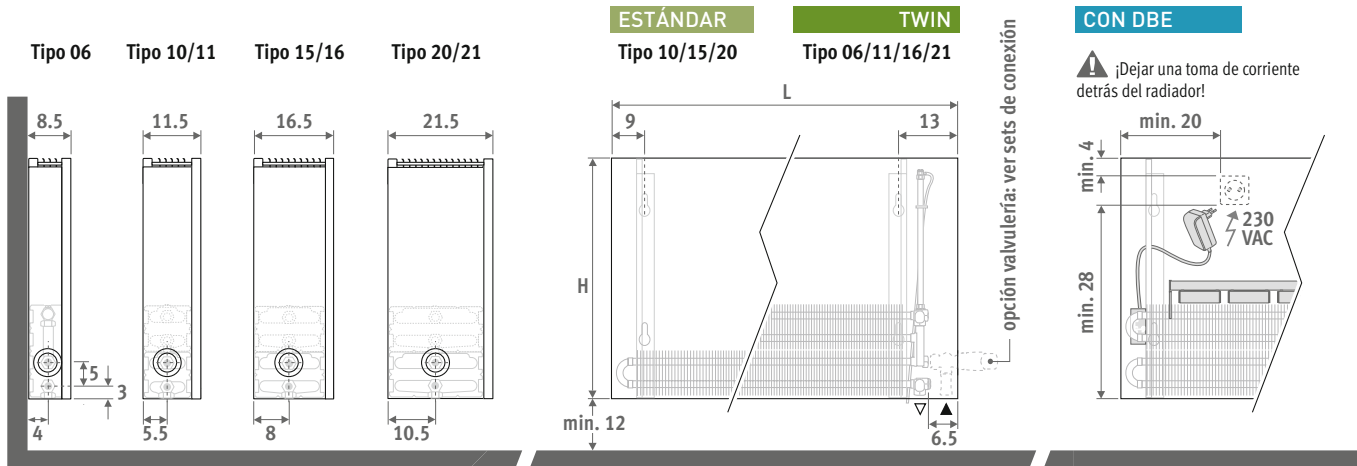

## ENTREGA

Fácil de instalar por una sola persona. Suministrado en una útil caja de cartón que sirve también como protección durante la obra.

Suministro estándar:

- intercambiador de calor Low-H<sub>2</sub>O con soportes de pared, kit de fijación, purgador extendido 1/8" y tapón de vaciado 1/2"
- carcasa parcialmente premontada para conexión inferior izquierda o derecha
- tapa-embellecedor efecto acero inoxidable para la abertura no utilizada

Suministro con DBE (opcional):

- el número de unidades DBE varía según la longitud
- mando, control y alimentación 12 VDC
- instrucciones de montaje sencillas
- embalado con el radiador

## COLORES

Respetuoso con el medio ambiente, lacado en polvo resistente al rayado con alta resistencia a los UV.

Colores estándar:

- blanco tráfico RAL 9016 (133), "soft touch" satinado ligeramente estructurado
- gris metálico arena (001), textura fina metálica

Otros colores: ver carta de colores.

## CONEXIÓN

Conexión estándar:

Conexión inferior izquierda o derecha, reversible en obra. Hacia la pared completamente oculto o hacia pared o suelo con 2 llaves de cierre justo por debajo del radiador.

Impulsión y retorno siempre a 5 cm en horizontal justo por debajo del radiador o vertical dentro de la carcasa, según la valvulería elegida.

Cabezal arriba opcional:

Añadir al código del radiador /30 (izquierda) o /60 (derecha)

Ej. STRW.035 050 06.XXX/60

Precios ver página 138.

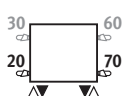

Para regulación fuera del radiador:

Añadir al código del radiador /00 para los 2 laterales cerrados. Ej. STRW.035 050 06.XXX/00 Solo con llave termostática vertical (para actuador térmico o control a distancia), 2 detentores o válvulas en el colector de distribución.

## SETS DE CONEXIÓN

Hacia la pared, totalmente oculta dentro de la carcasa

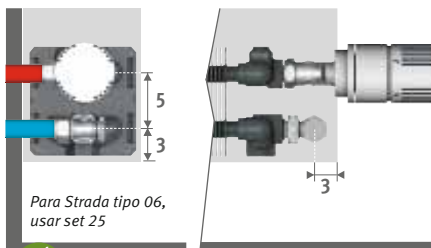

Cabezal termostático y racores Eurocono 3/4" incluidos.



Para Strada tipo 06, usar set 25

set 225

### CÓDIGO BITUBO

		€
	COLO.SW2.JC.4...	66,60
	COLO.SW2.JW.4...	57,00

completar con el código del racor

Tubo de cobre / acero fino 15/1 115

Tubo PER/ALU 16/2 616

## Otras conexiones:

Ver sección "Sets de conexión y válvulas" para todas las opciones de conexión e información técnica.



## CÓDIGO PEDIDO

código	altura	longitud	tipo	color
STRW . 020	050	10 . XXX		

indicar código de color ↓

## CÓDIGO DE PEDIDO CON DBE

código	altura	longitud	tipo	color	opción
STRW . 020	060	06 . XXX			/DBE

indicar código de color ↓

El DBE debería seleccionarse según la potencia en modo confort, como se especifica en la tabla de precios. El cambio entre el modo stand-by y el modo confort es automático dependiendo de la demanda de calor. Garantiza un funcionamiento silencioso. Para potencias en modo Boost ver: [www.jaga.info](http://www.jaga.info)



## TOALLERO

en aluminio cromado

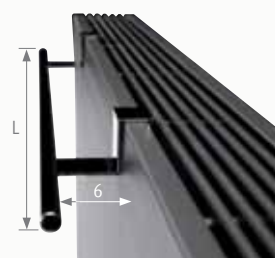

CÓDIGO	L	€
5501.001	56	204,70
5501.002	66	204,70

Suministro con ventilación (opcional): ver Jaga Oxygen - [www.jagaventilacion.com](http://www.jagaventilacion.com)

## STRW.020 LLL TT.XXX

## STRW.020 LLL TT.XXX/DBE

L	ESTÁNDAR					TWIN				
	Tipo	watios 65/55	watios 55/45	€ color est.	€ otro	Tipo	watios 65/55	watios 55/45	€ color est.	€ otro
050	---	---	---	---	---	06	196	131	173,80	222,10
	10	239	159	156,40	209,10	---	---	---	---	---
	15	398	265	185,70	243,20	---	---	---	---	---
	20	559	373	213,90	276,60	---	---	---	---	---
060	---	---	---	---	---	06	236	157	186,00	238,20
	10	287	191	168,50	225,40	---	---	---	---	---
	15	478	319	199,50	260,40	---	---	---	---	---
	20	671	448	231,90	298,30	---	---	---	---	---
070	---	---	---	---	---	06	275	183	206,10	260,50
	10	335	223	188,50	248,80	---	---	---	---	---
	15	557	372	225,60	290,50	---	---	---	---	---
	20	783	522	267,90	340,40	---	---	---	---	---
080	---	---	---	---	---	06	314	209	218,90	276,70
	10	382	255	200,50	264,10	---	---	---	---	---
	15	637	425	244,60	315,20	---	---	---	---	---
	20	895	597	289,80	367,40	---	---	---	---	---
090	---	---	---	---	---	06	353	236	229,60	289,80
	10	430	287	210,90	277,50	---	---	---	---	---
	15	717	478	259,90	334,30	---	---	---	---	---
	20	1007	672	308,30	389,90	---	---	---	---	---
100	---	---	---	---	---	06	393	262	246,70	308,90
	10	478	318	228,60	298,00	---	---	---	---	---
	15	796	531	282,60	360,00	---	---	---	---	---
	20	1119	746	339,00	425,20	---	---	---	---	---
110	---	---	---	---	---	06	432	288	259,90	325,60
	10	526	350	240,70	314,30	---	---	---	---	---
	15	876	584	298,80	380,10	---	---	---	---	---
	20	1231	821	360,90	452,40	---	---	---	---	---
120	---	---	---	---	---	06	472	314	276,50	347,90
	10	573	382	259,60	340,90	---	---	---	---	---
	15	955	637	323,40	414,30	---	---	---	---	---
	20	1342	895	395,00	500,10	---	---	---	---	---
140	---	---	---	---	---	06	550	366	299,80	374,80
	10	669	446	282,60	368,50	---	---	---	---	---
	15	1115	743	353,90	449,10	---	---	---	---	---
	20	1567	1045	453,90	562,60	---	---	---	---	---
160	---	---	---	---	---	06	629	419	353,00	441,30
	10	765	509	334,60	435,70	---	---	---	---	---
	15	1274	850	423,10	535,50	---	---	---	---	---
	20	1790	1194	541,00	668,90	---	---	---	---	---
180	---	---	---	---	---	06	707	471	379,80	474,40
	10	860	573	362,80	472,50	---	---	---	---	---
	15	1433	956	461,00	583,60	---	---	---	---	---
	20	2014	1343	586,80	724,90	---	---	---	---	---
200	---	---	---	---	---	06	786	524	412,80	518,70
	10	956	637	394,90	516,10	---	---	---	---	---
	15	1592	1062	527,20	664,10	---	---	---	---	---
	20	2238	1493	640,00	793,20	---	---	---	---	---
240	---	---	---	---	---	06	943	628	517,20	653,00
	10	1147	764	496,50	650,00	---	---	---	---	---
	15	1911	1274	660,10	832,80	---	---	---	---	---
	20	2686	1791	804,60	997,70	---	---	---	---	---
280	---	---	---	---	---	06	1099	733	580,00	731,90
	10	1338	891	557,80	729,80	---	---	---	---	---
	15	2229	1487	743,00	937,00	---	---	---	---	---
	20	3133	2090	908,00	1124,00	---	---	---	---	---

Factor corrección de 65/55 a 75/65:estándar: 1,36  
DBE: 1,25

Emisiones según EN442 a 20°C de temperatura ambiente

Tipo	CON DBE en modo confort				
	watios 65/55	watios 55/45	watios 45/40	€ color est.	€ otro
---	---	---	---	---	---
---	---	---	---	---	---
---	---	---	---	---	---
---	---	---	---	---	---
---	---	---	---	---	---
10	434	326	244	365,70	422,60
15	723	542	407	406,40	467,20
20	935	701	526	439,00	505,30
---	---	---	---	---	---
10	487	365	274	385,50	445,80
15	810	608	456	432,70	497,50
20	1058	793	595	474,90	547,30
---	---	---	---	---	---
10	539	404	303	397,70	461,20
15	898	673	505	451,60	522,10
20	1181	886	664	496,70	574,30
---	---	---	---	---	---
10	712	534	401	482,30	549,00
15	1185	889	666	551,30	625,50
20	1503	1127	846	599,70	681,10
---	---	---	---	---	---
10	764	573	430	499,90	569,40
15	1272	954	716	573,90	651,40
20	1626	1219	914	630,30	716,50
---	---	---	---	---	---
10	817	613	459	512,10	585,70
15	1359	1019	765	590,10	671,50
20	1748	1311	983	652,30	743,80
---	---	---	---	---	---
10	869	652	489	531,00	612,20
15	1446	1085	814	614,60	705,60
20	1870	1403	1052	686,20	791,30
---	---	---	---	---	---
10	974	730	548	553,90	640,00
15	1621	1216	912	645,30	740,20
20	2116	1587	1190	745,20	853,90
---	---	---	---	---	---
10	1318	989	742	754,90	856,00
15	2195	1646	1235	883,30	995,60
20	2761	2071	1553	1001,10	1129,10
---	---	---	---	---	---
10	1423	1067	801	783,10	892,90
15	2370	1777	1333	921,10	1043,60
20	3006	2255	1691	1047,10	1185,00
---	---	---	---	---	---
10	1528	1146	860	815,10	936,50
15	2544	1908	1431	987,20	1124,20
20	3251	2438	1829	1100,20	1253,40
---	---	---	---	---	---
10	1978	1483	1112	1065,50	1219,20
15	3293	2470	1852	1288,90	1461,60
20	4142	3106	2330	1433,60	1626,60
---	---	---	---	---	---
10	2187	1640	1230	1127,10	1299,20
15	3642	2731	2048	1371,80	1565,80
20	4632	3474	2606	1536,90	1753,00



# STRADA H035

## STRW.035 LLL TT.XXX

L	ESTÁNDAR					TWIN				
	Tipo	watios 65/55	watios 55/45	€ color est.	€ otro	Tipo	watios 65/55	watios 55/45	€ color est.	€ otro
050	---	---	---	---	---	06	289	194	227,30	283,70
	10	329	220	173,30	233,90	11	434	287	260,10	320,50
	15	539	361	202,70	269,30	16	576	378	306,30	372,80
	20	755	506	231,90	303,40	21	761	498	327,40	399,10
060	---	---	---	---	---	06	347	233	243,50	304,90
	10	394	264	186,70	252,80	11	521	344	278,00	343,80
	15	647	434	218,10	288,90	16	690	454	328,70	399,50
	20	906	608	251,20	327,40	21	913	598	354,30	430,50
070	---	---	---	---	---	06	405	271	270,30	334,00
	10	460	308	207,40	277,40	11	607	401	310,80	380,70
	15	755	506	244,70	320,20	16	805	529	372,20	447,70
	20	1057	709	287,90	370,70	21	1066	698	407,20	490,20
080	---	---	---	---	---	06	463	310	286,40	354,20
	10	525	351	220,60	294,30	11	694	459	330,00	403,70
	15	862	578	264,70	346,10	16	920	605	400,90	482,30
	20	1209	810	310,80	399,30	21	1218	797	438,70	527,30
090	---	---	---	---	---	06	521	349	301,50	373,40
	10	591	395	233,20	311,10	11	780	516	347,30	425,20
	15	970	650	282,00	369,20	16	1036	681	426,80	513,80
	20	1360	911	331,20	425,20	21	1370	897	467,10	560,90
100	---	---	---	---	---	06	579	388	323,80	397,80
	10	657	439	250,80	332,30	11	867	573	375,30	456,70
	15	1078	723	305,10	395,40	16	1151	756	463,80	554,10
	20	1511	1013	362,40	461,10	21	1522	997	512,60	611,50
110	---	---	---	---	---	06	637	427	340,80	418,90
	10	723	483	264,30	350,40	11	954	631	394,80	480,70
	15	1186	795	322,50	417,30	16	1265	832	489,00	583,80
	20	1662	1114	385,40	490,20	21	1674	1096	544,60	649,30
120	---	---	---	---	---	06	695	465	360,40	444,50
	10	789	528	283,30	377,10	11	1041	688	419,40	513,20
	15	1294	867	347,20	451,70	16	1381	908	522,90	627,50
	20	1813	1215	419,40	538,10	21	1827	1196	587,10	705,80
140	---	---	---	---	---	06	811	543	395,60	485,00
	10	920	615	311,60	411,60	11	1214	802	462,80	562,80
	15	1509	1012	382,30	492,80	16	1611	1059	579,80	690,10
	20	2115	1418	483,80	607,60	21	2131	1396	686,20	810,10
160	---	---	---	---	---	06	926	620	463,30	568,10
	10	1052	703	366,50	484,00	11	1388	917	542,10	659,40
	15	1725	1156	454,50	584,20	16	1841	1210	686,80	816,70
	20	2417	1620	573,70	718,80	21	2435	1594	811,30	956,50
180	---	---	---	---	---	06	1042	698	498,20	611,20
	10	1183	791	397,00	524,90	11	1561	1032	585,10	713,10
	15	1940	1301	495,10	636,60	16	2071	1361	746,30	888,00
	20	2719	1823	622,10	779,10	21	2740	1794	879,00	1036,10
200	---	---	---	---	---	06	1158	776	539,20	664,80
	10	1314	879	431,10	571,90	11	1735	1146	631,60	772,40
	15	2156	1445	563,00	720,60	16	2301	1513	850,40	1008,00
	20	3021	2025	677,10	850,70	21	3044	1993	953,10	1126,50
240	---	---	---	---	---	06	1389	931	672,10	830,50
	10	1577	1055	540,00	716,30	11	2081	1375	786,50	962,70
	15	2587	1734	703,10	899,20	16	2761	1815	1057,80	1253,90
	20	3626	2431	849,20	1065,70	21	3653	2392	1192,30	1408,80
280	---	---	---	---	---	06	1621	1086	752,40	930,20
	10	1840	1230	605,60	803,40	11	2429	1605	879,80	1077,70
	15	3018	2024	789,80	1010,60	16	3221	2118	1186,10	1407,30
	20	4230	2836	956,40	1199,10	21	4262	2791	1341,20	1583,80

Factor corrección de 65/55 a 75/65: estándar: 1,36  
DBE: 1,25

Emisiones según EN442 a 20°C de temperatura ambiente

## STRW.035 LLL TT.XXX/DBE

Tipo	CON DBE en modo confort				
	watios 65/55	watios 55/45	watios 45/40	€ color est.	€ otro
---	---	---	---	---	---
---	---	---	---	---	---
---	---	---	---	---	---
---	---	---	---	---	---
06	487	365	274	435,10	496,50
11	814	611	458	474,90	540,90
16	1149	862	646	535,60	606,40
21	1398	1049	787	561,10	637,40
06	550	413	310	461,90	525,60
11	910	682	512	507,80	577,60
16	1276	957	718	579,20	654,70
21	1568	1176	882	614,00	697,00
06	614	460	345	478,10	545,80
11	1006	754	566	526,90	600,70
16	1403	1052	789	608,00	689,40
21	1737	1303	977	645,70	734,30
06	785	589	441	562,40	634,20
11	1341	1006	754	618,50	696,50
16	1915	1436	1077	718,10	805,00
21	2290	1718	1288	758,40	852,20
06	848	636	477	584,50	658,60
11	1437	1078	808	646,80	728,10
16	2042	1532	1149	755,30	845,40
21	2459	1844	1383	803,90	902,80
06	911	683	513	601,40	679,60
11	1533	1150	862	666,10	752,10
16	2170	1627	1220	780,30	875,10
21	2628	1971	1478	835,90	940,60
06	974	731	548	621,10	705,20
11	1628	1221	916	690,80	784,70
16	2298	1723	1292	814,20	918,80
21	2798	2098	1574	878,30	997,00
06	1101	826	619	656,40	745,70
11	1819	1364	1023	734,20	834,20
16	2552	1914	1436	871,20	981,50
21	3136	2352	1764	977,70	1101,40
06	1443	1082	812	862,30	967,00
11	2491	1868	1401	962,30	1079,70
16	3575	2681	2011	1146,80	1276,60
21	4242	3181	2386	1271,40	1416,60
06	1570	1177	883	897,20	1010,00
11	2682	2012	1509	1005,40	1133,30
16	3830	2872	2154	1206,40	1348,10
21	4580	3435	2576	1339,20	1496,20
06	1696	1272	954	938,30	1063,80
11	2874	2155	1616	1051,90	1192,70
16	4085	3064	2298	1310,50	1468,10
21	4918	3689	2767	1413,10	1586,60
06	2165	1624	1218	1209,10	1367,60
11	3736	2802	2102	1355,70	1532,00
16	5362	4022	3016	1686,50	1882,80
21	6363	4772	3579	1821,30	2037,90
06	2418	1813	1360	1289,60	1467,40
11	4119	3089	2317	1449,10	1647,00
16	5872	4404	3303	1815,40	2036,20
21	7039	5279	3960	1970,00	2212,70

# H050 - STRADA

STRW.050 LLL TT.XXX

STRW.050 LLL TT.XXX/DBE

L	ESTÁNDAR					TWIN				
	Tipo	watios 65/55	watios 55/45	€ color est.	€ otro	Tipo	watios 65/55	watios 55/45	€ color est.	€ otro
050	---	---	---	---	---	06	349	235	237,10	298,80
	10	395	265	184,00	250,70	11	503	332	272,00	338,70
	15	638	430	216,60	289,60	16	685	449	319,30	392,10
	20	893	602	248,00	327,10	21	927	605	343,60	422,70
060	---	---	---	---	---	06	418	282	253,70	320,70
	10	474	318	198,20	270,60	11	604	399	290,60	363,10
	15	766	516	232,60	310,50	16	822	539	341,90	419,80
	20	1071	722	268,00	352,40	21	1112	725	371,10	455,50
070	---	---	---	---	---	06	488	329	281,90	352,80
	10	553	371	220,20	297,90	11	704	465	324,80	402,30
	15	894	602	260,90	344,50	16	959	629	387,30	470,90
	20	1250	842	306,20	398,20	21	1297	846	425,70	517,70
080	---	---	---	---	---	06	558	376	299,30	374,60
	10	632	424	234,20	316,10	11	805	532	345,20	426,90
	15	1021	688	281,70	371,90	16	1095	719	416,80	506,90
	20	1428	962	329,90	428,50	21	1483	968	457,90	556,30
090	---	---	---	---	---	06	627	423	314,90	394,60
	10	711	477	247,40	334,00	11	905	598	362,80	449,40
	15	1149	774	299,80	395,60	16	1232	809	443,20	539,10
	20	1607	1083	351,10	455,10	21	1668	1088	486,90	590,90
100	---	---	---	---	---	06	697	470	337,60	420,00
	10	790	530	265,60	356,20	11	1006	665	391,30	481,80
	15	1276	860	323,20	423,10	16	1369	898	480,70	580,50
	20	1785	1203	382,90	492,20	21	1854	1209	533,00	642,40
110	---	---	---	---	---	06	767	517	356,00	443,20
	10	869	584	280,80	376,60	11	1106	732	412,10	508,10
	15	1404	946	342,00	447,10	16	1506	988	507,40	612,40
	20	1964	1323	407,10	523,20	21	2039	1330	566,40	682,70
120	---	---	---	---	---	06	836	564	376,70	470,80
	10	948	636	300,50	405,10	11	1207	798	437,90	542,50
	15	1532	1032	367,50	483,20	16	1643	1078	542,30	658,00
	20	2142	1443	442,20	573,00	21	2224	1451	610,10	740,90
140	---	---	---	---	---	06	976	658	415,00	515,60
	10	1106	742	331,80	444,10	11	1407	931	484,90	597,20
	15	1787	1204	407,20	529,90	16	1917	1258	602,90	725,70
	20	2499	1684	511,20	648,70	21	2595	1693	713,70	851,20
160	---	---	---	---	---	06	1115	752	486,30	604,80
	10	1264	849	390,50	522,40	11	1609	1064	567,80	699,80
	15	2042	1376	482,80	627,60	16	2191	1438	713,30	858,20
	20	2856	1924	604,70	765,90	21	2966	1935	842,50	1003,80
180	---	---	---	---	---	06	1255	846	522,60	650,40
	10	1422	955	422,40	565,90	11	1810	1197	612,40	755,80
	15	2297	1548	524,90	682,80	16	2464	1617	774,40	932,00
	20	3213	2165	654,70	828,80	21	3337	2177	911,40	1085,80
200	---	---	---	---	---	06	1395	940	565,70	707,60
	10	1580	1061	458,60	616,50	11	2011	1330	661,00	819,00
	15	2553	1720	594,80	770,00	16	2738	1797	880,40	1055,50
	20	3570	2405	711,60	903,90	21	3707	2418	987,60	1179,60
240	---	---	---	---	---	06	1674	1128	703,90	881,90
	10	1896	1273	573,00	769,50	11	2413	1596	822,00	1018,40
	15	3064	2064	741,40	958,30	16	3286	2156	1093,80	1310,60
	20	4284	2886	891,10	1129,20	21	4449	2902	1234,20	1472,40
280	---	---	---	---	---	06	1953	1316	788,90	989,10
	10	2212	1485	643,00	864,30	11	2816	1862	919,80	1140,80
	15	3574	2408	832,80	1077,30	16	3833	2516	1226,70	1471,40
	20	4998	3367	1002,90	1270,10	21	5191	3386	1387,60	1655,00

Tipo	CON DBE en modo confort				
	watios 65/55	watios 55/45	watios 45/40	€ color est.	€ otro
---	---	---	---	---	---
---	---	---	---	---	---
---	---	---	---	---	---
---	---	---	---	---	---
06	562	422	316	445,30	512,40
11	906	679	509	487,70	560,10
16	1295	971	729	548,80	626,80
21	1623	1217	913	577,90	662,30
06	638	479	359	473,50	544,40
11	1016	762	572	521,80	599,50
16	1447	1085	814	594,20	677,80
21	1830	1372	1029	632,70	724,60
06	714	536	402	490,90	566,20
11	1127	845	634	542,20	624,10
16	1598	1199	899	623,70	713,80
21	2037	1528	1146	664,90	763,20
06	898	673	505	575,60	655,40
11	1478	1108	831	634,10	720,80
16	2134	1601	1201	734,50	830,40
21	2627	1970	1478	778,20	882,30
06	974	730	548	598,30	680,80
11	1589	1192	894	662,80	753,20
16	2286	1715	1286	772,00	871,80
21	2834	2125	1594	824,20	933,70
06	1050	787	590	616,70	704,00
11	1700	1275	956	683,40	779,40
16	2438	1829	1372	798,70	903,70
21	3040	2280	1710	857,70	973,90
06	1125	844	633	637,50	731,50
11	1810	1358	1018	709,30	813,90
16	2590	1943	1457	833,60	949,20
21	3246	2435	1826	901,40	1032,30
06	1277	958	718	675,80	776,60
11	2032	1524	1143	756,20	868,60
16	2894	2170	1628	894,00	1016,90
21	3660	2745	2059	1005,00	1142,40
06	1644	1233	925	885,20	1003,80
11	2734	2051	1538	988,20	1120,10
16	3966	2974	2231	1173,40	1318,20
21	4841	3631	2723	1302,50	1463,90
06	1796	1347	1010	921,50	1049,40
11	2956	2217	1663	1032,90	1176,30
16	4269	3202	2401	1234,40	1392,30
21	5254	3941	2956	1371,70	1545,90
06	1947	1460	1095	964,60	1106,40
11	3178	2383	1787	1081,30	1239,30
16	4573	3430	2572	1340,60	1515,70
21	5667	4250	3188	1447,70	1639,70
06	2466	1850	1387	1241,20	1419,10
11	4101	3076	2307	1391,30	1587,60
16	5948	4461	3346	1722,50	1939,40
21	7262	5446	4085	1863,20	2101,30
06	2770	2077	1558	1326,20	1526,40
11	4545	3409	2556	1489,20	1710,20
16	6555	4916	3687	1855,80	2100,30
21	8088	6066	4550	2016,40	2283,90

Factor corrección de 65/55 a 75/65: estándar: 1,36  
DBE: 1,25

Emisiones según EN442 a 20°C de temperatura ambiente

# STRADA H065

## STRW.065 LLL TT.XXX

L	ESTÁNDAR					TWIN				
	Tipo	watios 65/55	watios 55/45	€ color est.	€ otro	Tipo	watios 65/55	watios 55/45	€ color est.	€ otro
050	---	---	---	---	---	06	394	267	247,20	314,30
	10	446	301	197,20	271,10	11	560	371	285,30	359,20
	15	710	481	232,10	313,20	16	783	513	335,70	416,60
	20	993	672	267,00	353,90	21	1085	705	361,40	448,30
060	---	---	---	---	---	06	474	321	264,60	337,70
	10	535	361	212,40	292,50	11	672	444	304,80	384,80
	15	852	577	249,00	335,40	16	939	615	359,30	445,60
	20	1191	806	288,00	380,60	21	1302	846	389,80	482,20
070	---	---	---	---	---	06	552	374	293,90	371,40
	10	624	421	235,50	321,30	11	784	518	340,00	425,90
	15	994	673	278,10	370,70	16	1096	718	405,60	498,20
	20	1389	941	326,90	427,90	21	1519	987	445,30	546,00
080	---	---	---	---	---	06	631	428	312,80	395,70
	10	714	481	251,00	342,30	11	895	592	361,60	452,80
	15	1137	770	300,60	401,10	16	1252	820	436,60	537,10
	20	1588	1075	352,40	460,70	21	1736	1128	479,20	587,50
090	---	---	---	---	---	06	710	481	328,80	416,50
	10	803	541	264,40	360,80	11	1008	667	379,90	476,30
	15	1279	866	319,20	425,60	16	1409	923	463,50	570,20
	20	1786	1210	374,00	488,20	21	1953	1269	508,40	622,70
100	---	---	---	---	---	06	789	535	352,20	443,00
	10	892	601	283,50	384,10	11	1120	741	409,10	509,70
	15	1420	962	343,10	454,00	16	1565	1026	501,60	612,50
	20	1984	1344	406,10	526,30	21	2170	1410	555,20	675,30
110	---	---	---	---	---	06	868	589	370,80	467,10
	10	981	661	298,80	405,20	11	1231	814	430,10	536,60
	15	1562	1058	362,50	478,80	16	1722	1128	528,70	645,10
	20	2183	1478	431,00	558,30	21	2386	1551	588,90	716,20
120	---	---	---	---	---	06	946	642	394,10	498,90
	10	1070	721	321,30	438,20	11	1344	889	458,60	575,50
	15	1704	1154	390,60	519,30	16	1879	1231	566,20	695,00
	20	2381	1613	468,70	612,30	21	2603	1692	635,10	778,80
140	---	---	---	---	---	06	1104	749	434,50	546,60
	10	1248	841	355,10	480,50	11	1567	1037	508,30	633,60
	15	1989	1347	433,20	570,00	16	2191	1436	630,40	767,20
	20	2778	1881	542,40	693,40	21	3037	1975	743,10	894,00
160	---	---	---	---	---	06	1262	856	508,70	640,70
	10	1427	962	416,80	563,70	11	1792	1185	594,10	741,00
	15	2273	1539	511,80	672,50	16	2505	1641	743,90	904,40
	20	3175	2150	638,80	815,70	21	3471	2257	874,80	1051,60
180	---	---	---	---	---	06	1420	963	547,30	690,00
	10	1605	1082	450,80	610,90	11	2015	1333	640,80	800,80
	15	2557	1732	556,00	731,20	16	2817	1846	806,90	982,10
	20	3572	2419	690,90	882,20	21	3905	2539	946,20	1137,40
200	---	---	---	---	---	06	1577	1070	592,90	751,30
	10	1784	1202	489,30	665,60	11	2239	1481	691,70	867,90
	15	2841	1924	628,60	822,70	16	3131	2051	915,60	1109,90
	20	3969	2688	750,70	961,70	21	4339	2821	1024,60	1235,60
240	---	---	---	---	---	06	1893	1284	736,70	934,40
	10	2140	1443	610,10	828,10	11	2687	1777	858,90	1077,00
	15	3409	2309	781,70	1020,90	16	3757	2461	1136,00	1375,30
	20	4763	3225	938,10	1198,40	21	5207	3385	1278,80	1539,20
280	---	---	---	---	---	06	2209	1498	825,40	1048,20
	10	2497	1683	684,00	929,20	11	3135	2073	960,70	1205,70
	15	3978	2694	876,90	1146,60	16	4383	2871	1273,20	1542,60
	20	5556	3763	1053,90	1346,10	21	6075	3949	1436,10	1728,30

Factor corrección de 65/55 a 75/65: estándar: 1,36  
DBE: 1,25

Emisiones según EN442 a 20°C de temperatura ambiente

## STRW.065 LLL TT.XXX/DBE

Tipo	CON DBE en modo confort				
	watios 65/55	watios 55/45	watios 45/40	€ color est.	€ otro
---	---	---	---	---	---
---	---	---	---	---	---
---	---	---	---	---	---
---	---	---	---	---	---
06	620	465	349	456,10	529,30
11	981	736	552	501,80	581,80
16	1427	1070	803	566,20	652,50
21	1838	1379	1034	596,70	689,30
06	705	529	396	485,40	563,00
11	1104	828	621	537,00	622,80
16	1601	1201	900	612,50	705,30
21	2081	1561	1170	652,00	753,00
06	790	593	445	504,40	587,30
11	1227	920	690	558,60	649,80
16	1774	1331	998	643,50	744,10
21	2323	1742	1307	686,00	794,40
06	983	737	553	589,60	677,30
11	1591	1193	895	651,30	747,70
16	2333	1750	1312	754,90	861,40
21	2950	2212	1659	799,70	914,00
06	1069	802	601	613,00	703,80
11	1714	1286	964	680,50	781,20
16	2506	1880	1410	792,90	903,70
21	3192	2394	1796	846,50	966,70
06	1154	866	649	631,50	727,90
11	1838	1378	1034	701,70	808,10
16	2680	2010	1508	820,00	936,40
21	3434	2576	1932	880,10	1007,40
06	1239	929	697	654,90	759,60
11	1962	1471	1103	730,10	847,00
16	2854	2141	1606	857,70	986,30
21	3677	2758	2068	926,50	1070,10
06	1410	1057	793	695,30	807,40
11	2208	1656	1242	779,60	905,00
16	3202	2401	1801	921,90	1058,50
21	4162	3121	2341	1034,30	1185,20
06	1797	1348	1011	907,70	1039,60
11	2935	2201	1651	1014,30	1161,30
16	4318	3238	2429	1204,00	1364,60
21	5414	4061	3046	1335,00	1511,70
06	1967	1475	1107	946,20	1088,90
11	3182	2386	1790	1061,10	1221,20
16	4665	3499	2624	1267,10	1442,20
21	5899	4424	3318	1406,10	1597,40
06	2138	1603	1202	991,80	1150,30
11	3429	2572	1929	1112,00	1288,20
16	5013	3760	2820	1375,70	1570,00
21	6384	4788	3591	1484,70	1695,80
06	2694	2021	1516	1273,80	1471,70
11	4402	3302	2476	1428,30	1646,20
16	6476	4857	3643	1764,90	2004,10
21	8122	6091	4568	1908,00	2168,20
06	3036	2277	1708	1362,80	1585,50
11	4896	3672	2754	1530,10	1775,10
16	7171	5378	4034	1902,00	2171,50
21	9091	6818	5114	2065,20	2357,30



# H095 - STRADA

STRW.095 LLL TT.XXX

STRW.095 LLL TT.XXX/DBE

L	ESTÁNDAR					TWIN				
	Tipo	watios 65/55	watios 55/45	€ color est.	€ otro	Tipo	watios 65/55	watios 55/45	€ color est.	€ otro
050	---	---	---	---	---	---	---	---	---	---
060	---	---	---	---	---	06	550	378	284,50	369,90
	10	620	421	233,30	325,70	11	783	518	325,60	417,90
	15	959	656	275,50	375,70	16	1154	753	385,80	486,10
	20	1337	915	313,00	419,40	21	1675	1081	416,20	522,60
070	---	---	---	---	---	06	641	440	314,80	405,10
	10	723	491	257,20	356,10	11	913	604	361,70	460,60
	15	1119	765	305,60	412,90	16	1346	879	433,10	540,40
	20	1560	1067	352,90	468,50	21	1954	1261	472,50	588,10
080	---	---	---	---	---	06	733	503	336,10	434,00
	10	826	561	275,20	381,40	11	1043	691	386,10	492,30
	15	1279	875	330,70	447,50	16	1539	1005	466,60	583,50
	20	1783	1220	380,90	505,70	21	2233	1441	508,80	633,80
090	---	---	---	---	---	06	824	566	354,20	458,10
	10	929	631	291,00	403,70	11	1173	777	406,20	518,80
	15	1438	984	351,10	475,30	16	1731	1130	495,60	620,00
	20	2006	1372	404,60	536,70	21	2512	1621	540,50	672,70
100	---	---	---	---	---	06	916	629	382,20	492,80
	10	1032	701	314,80	435,00	11	1304	863	440,50	560,70
	15	1598	1093	380,10	512,00	16	1923	1256	538,60	670,50
	20	2229	1524	441,60	583,10	21	2791	1801	592,10	733,50
110	---	---	---	---	---	06	1008	692	404,30	522,40
	10	1135	771	333,20	461,40	11	1435	950	464,70	593,00
	15	1759	1203	402,40	542,30	16	2116	1381	568,80	708,60
	20	2451	1677	469,60	620,40	21	3070	1982	629,00	779,80
120	---	---	---	---	---	06	1099	754	428,40	555,50
	10	1239	842	356,60	495,60	11	1565	1036	493,80	633,10
	15	1918	1312	431,60	584,10	16	2308	1507	607,30	759,80
	20	2674	1829	508,20	675,80	21	3349	2162	676,20	843,60
140	---	---	---	---	---	06	1282	880	476,10	614,70
	10	1445	982	398,10	550,00	11	1826	1208	551,30	703,20
	15	2238	1531	483,80	648,60	16	2693	1758	680,90	845,60
	20	3120	2134	590,70	770,00	21	3908	2522	793,50	972,80

Factor corrección de 65/55 a 75/65: estándar: 1,36  
DBE: 1,25

Emisiones según EN442 a 20°C de temperatura ambiente

Tipo	CON DBE en modo confort				
	watios 65/55	watios 55/45	watios 45/40	€ color est.	€ otro
---	---	---	---	---	---
06	697	523	392	476,10	561,50
11	1102	827	620	522,50	615,00
16	1669	1252	939	592,80	692,90
21	2266	1699	1274	623,30	729,50
06	794	596	447	506,20	596,70
11	1246	934	701	558,80	657,60
16	1883	1412	1059	640,10	747,40
21	2579	1934	1451	679,40	795,00
06	893	670	502	527,70	625,60
11	1390	1042	782	583,30	689,40
16	2098	1573	1180	673,50	790,40
21	2893	2170	1627	715,90	840,70
06	1098	824	618	614,80	718,90
11	1773	1330	997	677,60	790,20
16	2695	2021	1516	786,90	911,10
21	3590	2693	2020	831,80	964,00
06	1197	898	673	643,00	753,50
11	1917	1438	1078	711,90	832,20
16	2910	2182	1637	829,90	961,80
21	3904	2928	2196	883,40	1024,70
06	1295	971	729	665,00	783,10
11	2061	1546	1159	735,90	864,40
16	3124	2343	1757	860,10	999,90
21	4218	3163	2372	920,20	1071,00
06	1393	1045	783	689,20	816,30
11	2204	1653	1240	765,30	904,50
16	3338	2503	1877	898,60	1051,10
21	4531	3398	2549	967,20	1134,90
06	1589	1192	894	736,90	875,50
11	2491	1868	1401	822,60	974,50
16	3766	2825	2119	972,20	1136,90
21	5158	3869	2902	1084,90	1264,20

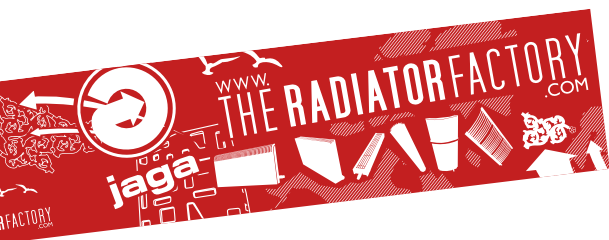

Jaga España  
Conves Termic s.l.

Tel.: 902 002 456  
M+34 673514587  
proyectos@conves.es  
www.jaga.info

Jaga International  
Verbindingslaan 16  
B-3590 Diepenbeek

T: +32 11 29 41 16  
F: +32 11 29 41 60  
export@jaga.be  
www.theradiatorfactory.com

La información de esta lista de precios es correcta en el período indicado. Jaga se reserva el derecho de cambiar las especificaciones de sus productos en cualquier momento en línea con su política de continua mejora e innovación.  
Precios válidos desde el 1 de marzo de 2018. IVA no incluido en todos los precios.  
Reemplaza a todas las listas de precios anteriores.